

04

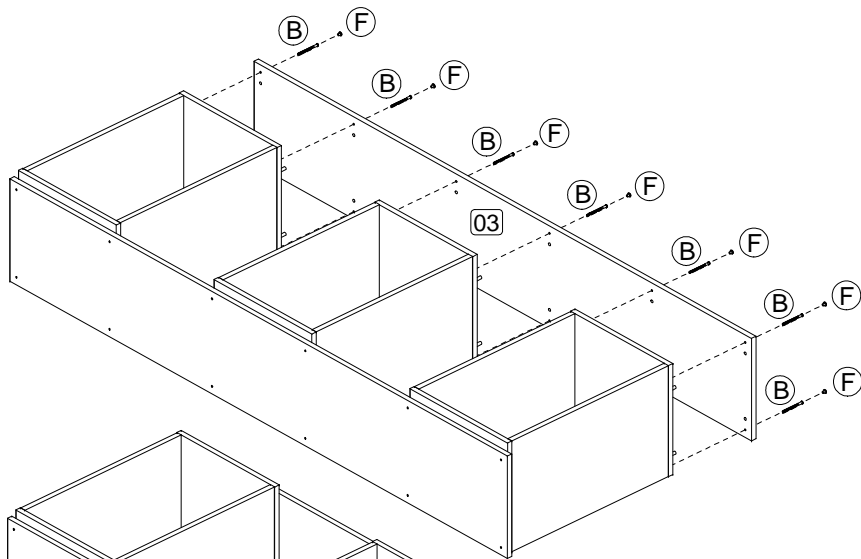

05

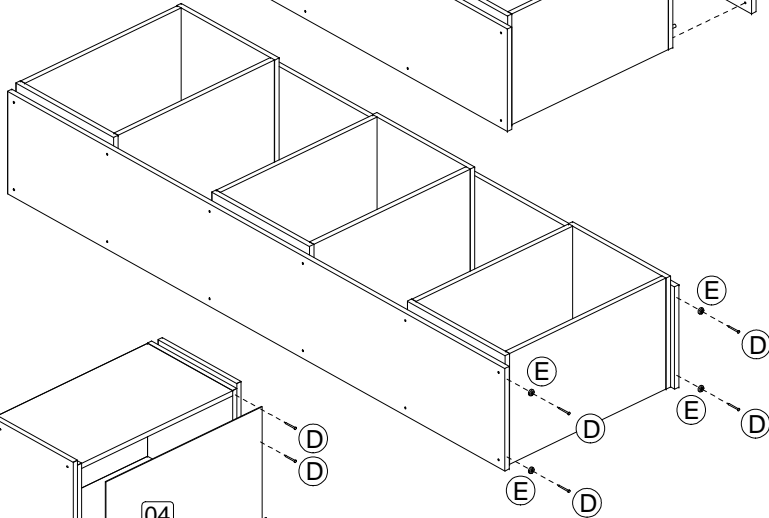

06

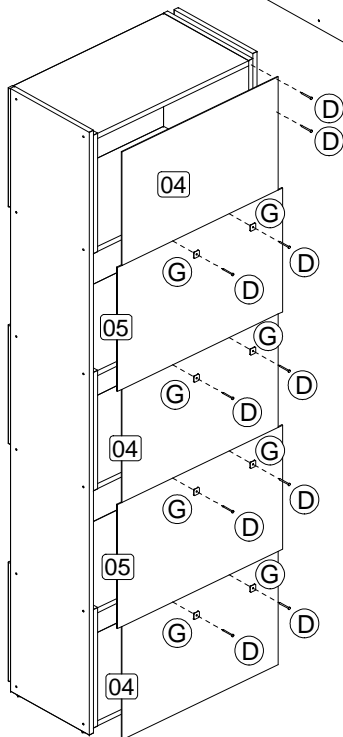

ATENÇÃO!!!
 Utilize o giz de cera para dar acabamento nas arestas e correções de possíveis riscos nas peças.

ATENCIÓN!!!
 Utilice el gis para los bordes y correcciones de posibles errores o daños en las piezas.

ATTENTION!!!
 Use the crayons to finish edges and to fix possible damaged pieces.

INSTRUÇÕES DE MONTAGEM
INSTRUCTIVO DE ARMADO
ASSEMBLY INSTRUCTIONS



RSC 470 - km 203,3 BENTO GONÇALVES - RS - BRASIL
 FONE: 54-3458.1300
 sac@politorno.com.br
 www.politorno.com.br

Estante Larga Dubai
Estantería Dubai 595mm
Bookcase Dubai 23"





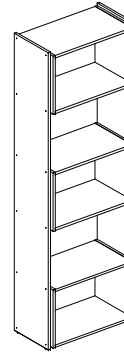

Modelo
Modelo
Modelo

2435

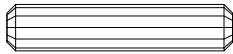
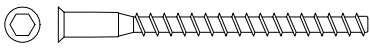

Caso você precise da indicação de um montador, consulte o site www.politorno.com.br. Temos profissionais capacitados para indicar nas principais cidades do Brasil.

KIT FERRAGEM
KIT HERRAJE
HARDWARE KIT

A	 08x45	24
B	 5,0x50	24
C		01
D		55
E		04
F		24
G		08
H	 Giz / Gis / Crayons	02

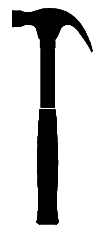

ANTES DE INICIAR A MONTAGEM, IDENTIFIQUE TODAS AS PEÇAS E ACESSÓRIOS.
 ANTES DE EMPEZAR EL ARMADO, IDENTIFIQUE TODAS LAS PIEZAS Y ACCESORIOS.
 BEFORE STARTING THE ASSEMBLY, IDENTIFY ALL PARTS AND ACCESSORIES.

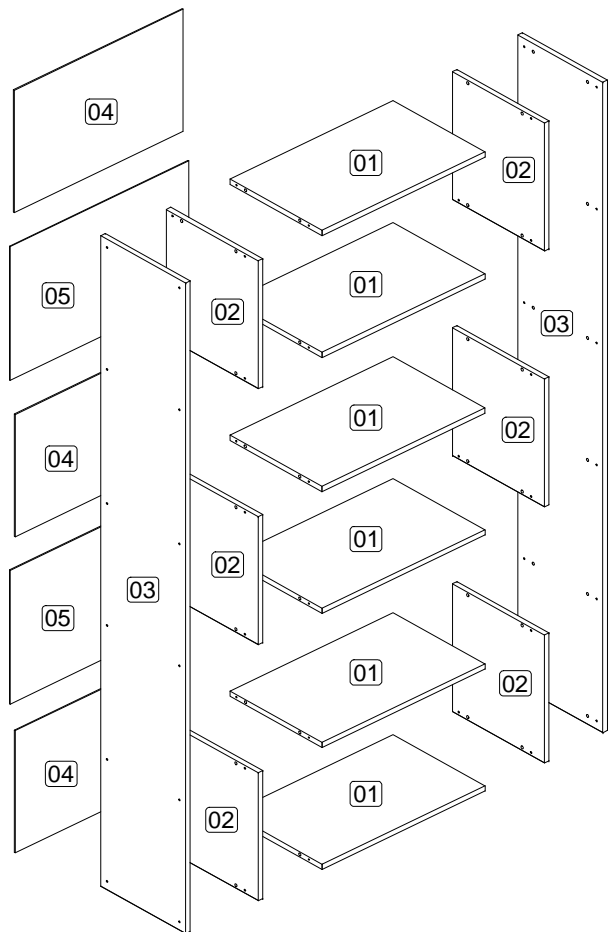

ETAPA DE PREPARAÇÃO DAS PEÇAS.
 FASE DE PREPARACIÓN DE LAS PIEZAS.
 STAGE OF PREPARATION OF THE PIECES.

01

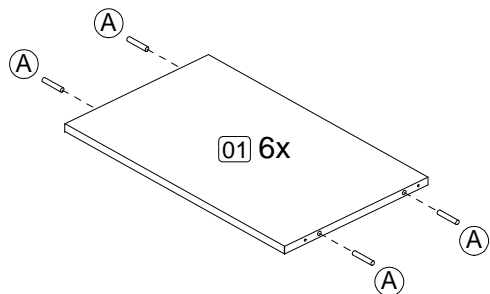

02 (3x)

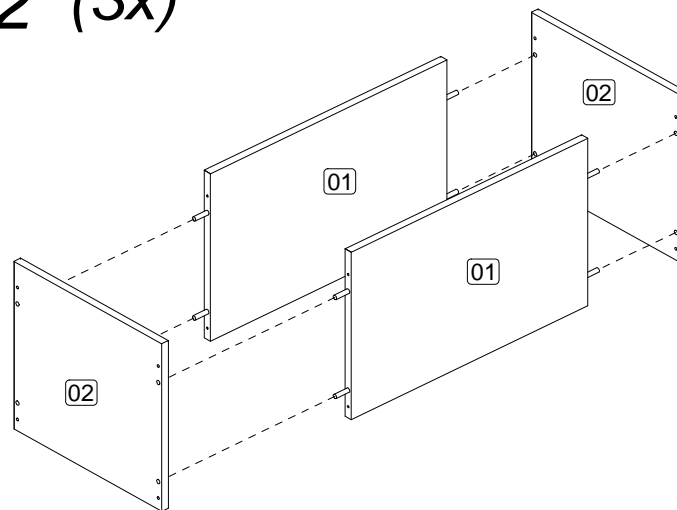

03

