

GUARDA-ROUPA

10 portas - 3 gavetas
Corrediça Metálica

18490-61 New Tab./Grafite
18490-63 New Tab./Amêndoa
18490-70 Branco/Mosaico
18490-85 Noce/Linho

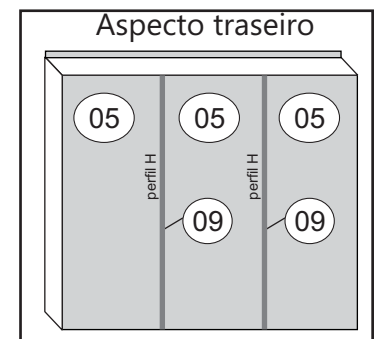
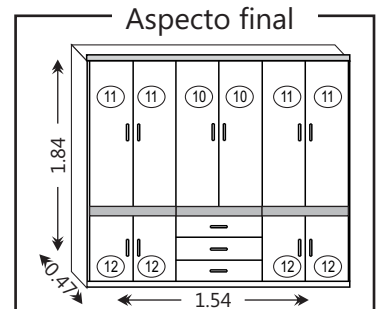
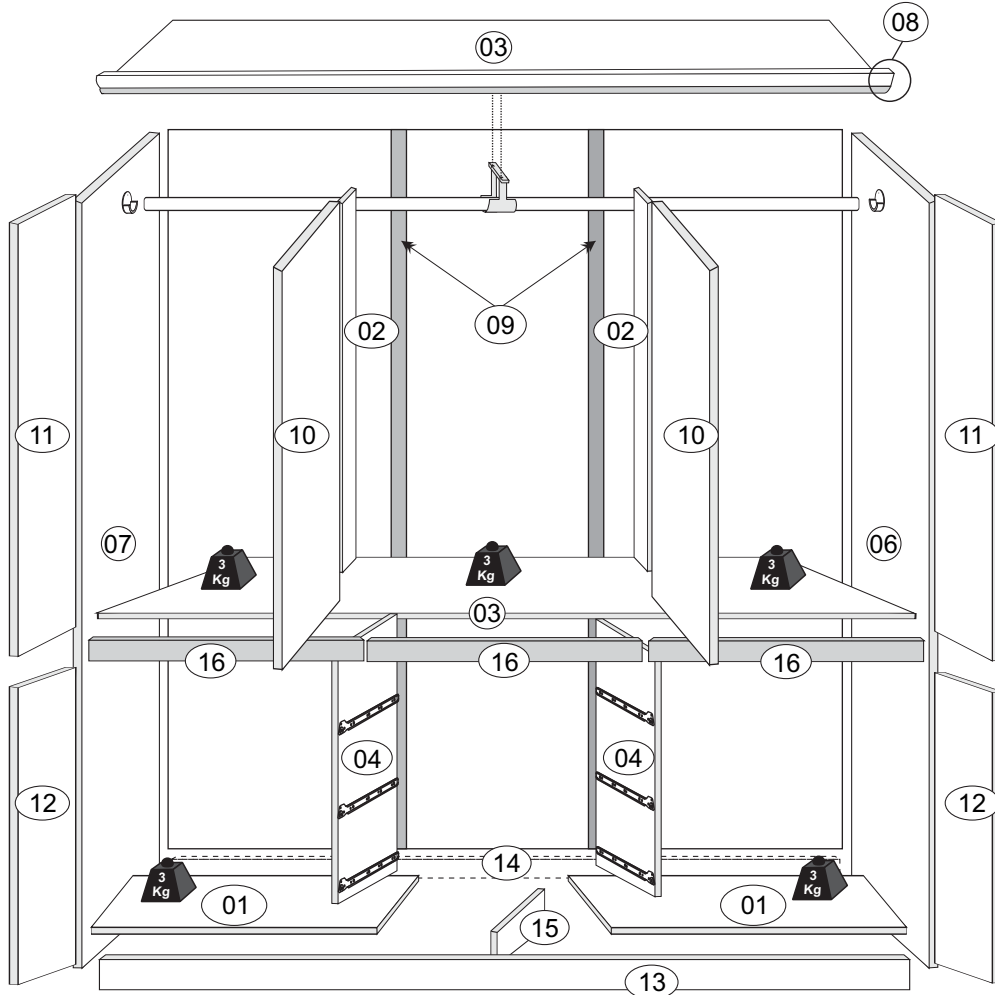
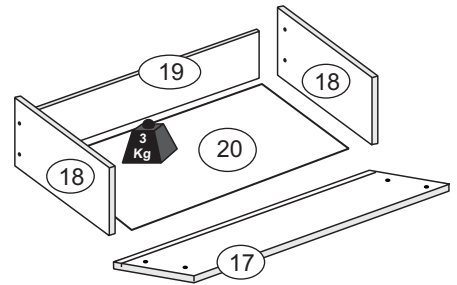

ATENÇÃO

Ao realizar solicitações de Assistência Técnica, favor seguir as orientações abaixo:

1º - Informar o **MODELO** do Roupeiro (Ex.: 18490-70)

2º - Informar o **CÓDIGO** da Peça (Ex.: 23)

3º - Informar o **CÓDIGO** do revestimento da Peça (Ex.: 100)

As solicitações de peças deverão ser encaminhado via email:

assistencia@araplac.com.br / at@araplac.com.br / ligia@araplac.com.br / eduardo@araplac.com.br / at@araplac.com.br

Legenda de Peças

Peça	Descrição	Medida (mm)	Qtde.	Código da PEÇA p/ Assistência Técnica	New Tab./Grafite	New Tab./Amen.	Bco/Mos.	Noce/Linho	Mat. Prima
					CÓDIGO DO REVESTIMENTO DA PEÇA				
01	Base rodapé	525x450x8	02	23	120	120	100	184	MDP
02	Batente	1123x90x12	02	51	120	120	100	184	MDP
03	Base Prateleira / Chapéu	1515x450x12	02	101	120	120	100	184	MDP
04	Divisória	535x450x12	02	144	120	120	100	184	MDP
05	Fundo	500x1695x3	03	193	120	120	100	184	MDP
06	Lateral dir.	1840x450x12	01	234	120	120	100	184	DURATREE
07	Lateral esq.	1840x450x12	01	260	120	120	100	184	MDP
08	Moldura	1540x53x15	01	298	120	120	100	184	MDP
09	Coluna	1670x40x15	02	404	120	120	100	184	MDP
10	Porta central	1142x251x15	02	464	120	120	117	184	MDP
11	Porta maior lateral	1142x251x15	04	521	110	163	101	185	MDP
12	Porta menor lateral	476x251x15	04	489	110	163	101	185	MDP
13	Rodapé frontal	1515x100x15	01	566	120	120	100	184	MDP
14	Rodapé traseiro	1515x100x15	01	575	99	99	99	99	MDP
15	Trava do rodapé	419x100x15	01	580	99	99	99	99	MDP
16	Vista frontal	497x70x12	03	614	120	120	101	184	MDP
17	Frente da gav.	504x157x15	03	698	120	120	117	184	MDP
18	Lateral da gav.	370x100x12	06	704	120	120	100	184	MDP
19	Contra fundo da gav.	446x80x12	03	729	120	120	100	184	MDP
20	Fundo da gav.	380x470x3	03	758	120	120	100	184	DURATREE

Kit de Acessórios



Cavilha 6x30 - 28 Pçs

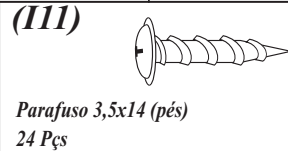
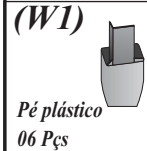
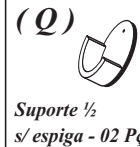
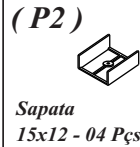
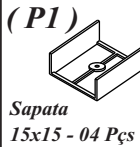
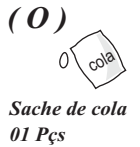
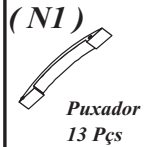
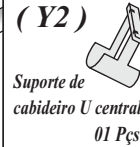
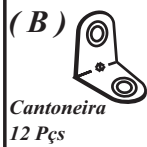
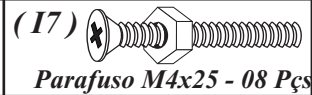
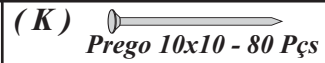

5

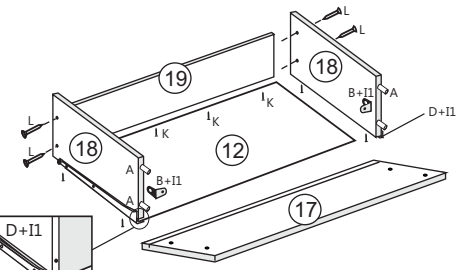
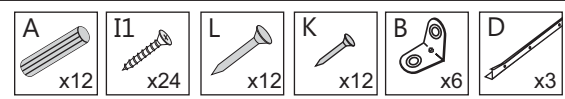

corredeira metálica

- 1º Encaixe as laterais na frente da gaveta com cavilhas, cantoneiras metálicas e cola.
- 2º Encaixar o fundo da gaveta e contra-fundo da gaveta.
- 3º Pregar as laterais no contra-fundo com prego 13x15.
- 4º Pregar o fundo da gaveta no contra-fundo por baixo com prego 10x10 e os parafusos da corredeira metálica servirão também para parafusar os fundos da gaveta nas laterais.

1

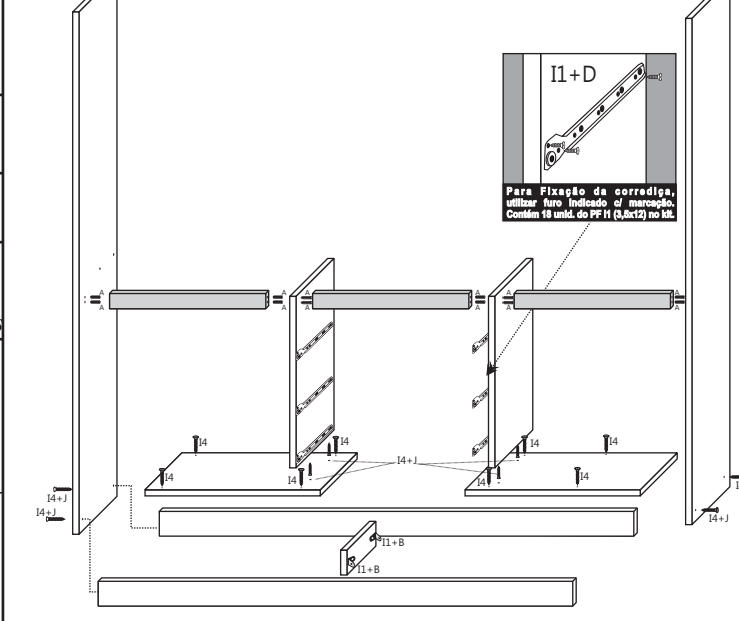
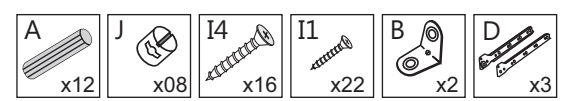

Para Fixação da corredeira, utilizar furo indicado cf. marcação. Contém 19 unidades do P2 I1 (3,5x12) no kit.

2

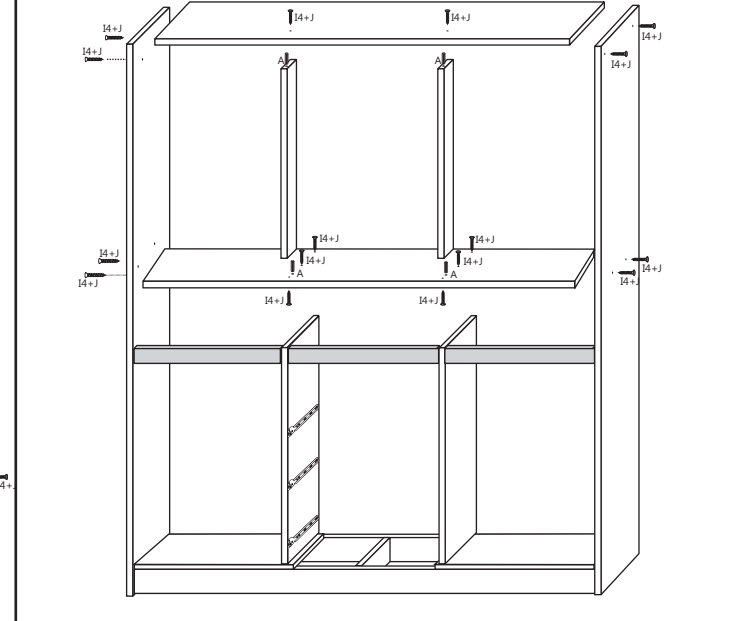
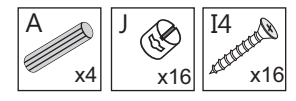

3

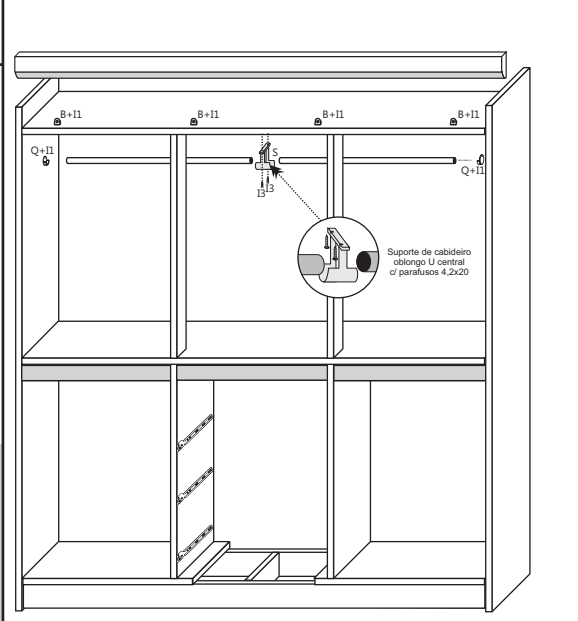
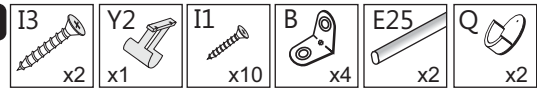

Suporte de cabideiro cobinço U central cf. parafusos 4,2x20

4

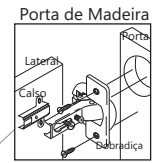
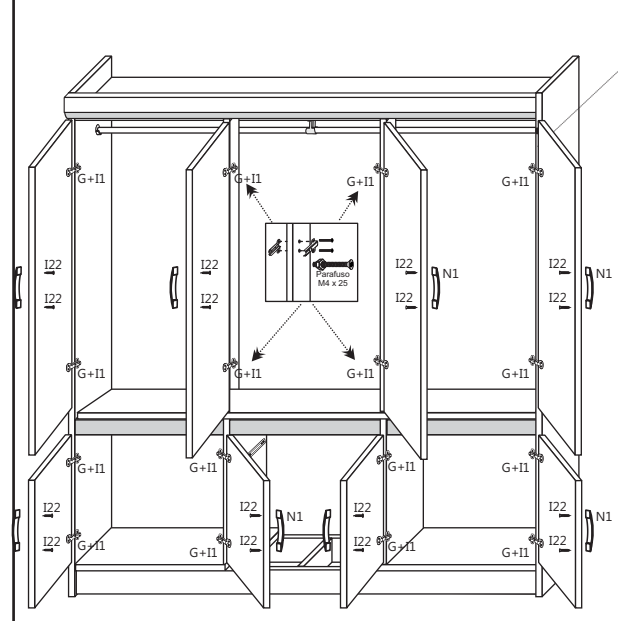
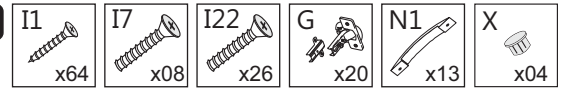

5



Obs.: Os parafusos utilizados para a fixação dos pés plásticos encontram-se em um sub-kit dentro do kit de acessórios principal.

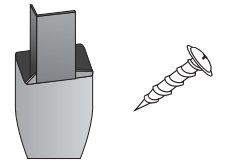

A montagem dos pés é opcional, e para tal basta posicioná-los, após o passo 01, internamente entre as laterais e rodapés, e parafusá-los de dentro para fora.