

**INSTRUÇÕES DE MONTAGEM
INSTRUCCIONES DE ARMADO
ASSEMBLY INSTRUCTIONS**

REF.: 2510

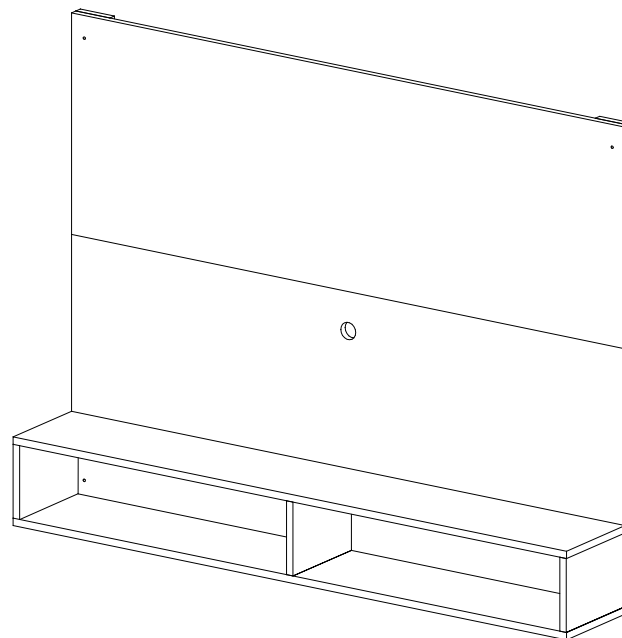







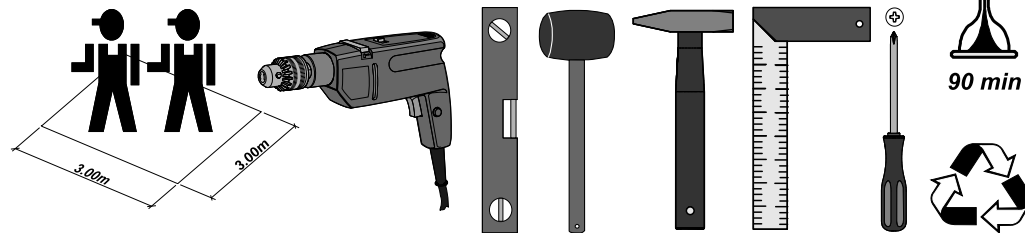





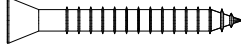

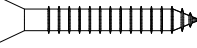

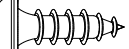

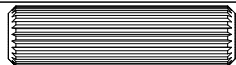

M
MULTIMÓVEIS
decor

Rua Beatriz Dall'Onder, 266 Fone:(54) 2102 4000, FAX:(54) 2102 4050
CEP 95706-350 - BENTO GONÇALVES - RS - BRASIL
CNPJ: 00.349.443/0001-92
e-mail: multimoveis@multimoveis.com / site: www.multimoveis.com

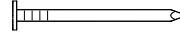
FERRAMENTAS NECESSÁRIAS
HERRAMIENTAS NECESARIAS
TOOLS NECESSARY



A			5,0 x 80	04
B			4,5 x 50	05
D			4,0 x 35	06
BA			4,0 x 25	12
F			3,5 x 14	06
CC			3,5 X 12	12
H			8,0 x 30	18
BZ			Sapata	04
AT			Peça L	06
BX			COLA	01
BQ			Suporte MC 60	03
ED			Tampa Adesiva Papel	08
Y			10 x 10	04
X			Bucha Ø8mm	04
N			Parafuso Minifix	02
O			Tambor Minifix	02

Utilizar a régua abaixo para medir as ferragens:

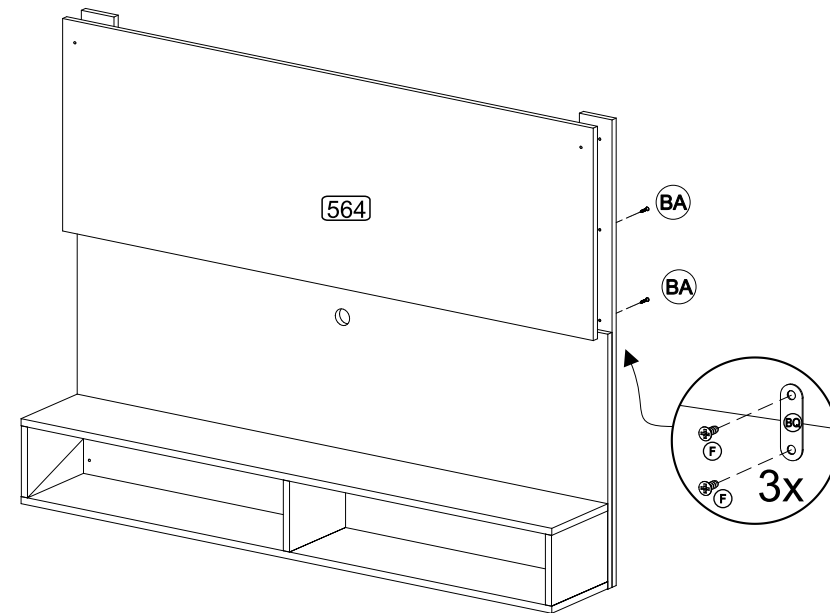

OBSERVAÇÃO:
É OBRIGATÓRIO fixar o painel na parede. Na imagem ao lado, está informado as medidas entre furos do painel, é uma sugestão para a instalação. Durante montagem será necessário a utilização de uma furadeira e um nível para alinhá-lo.

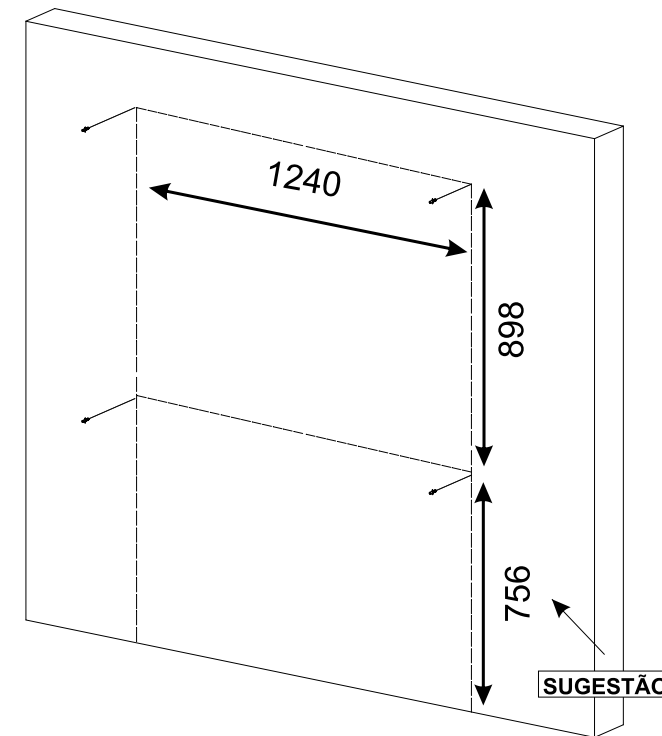
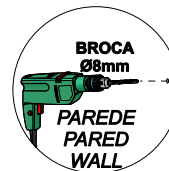

Passo
Paso
Step
05

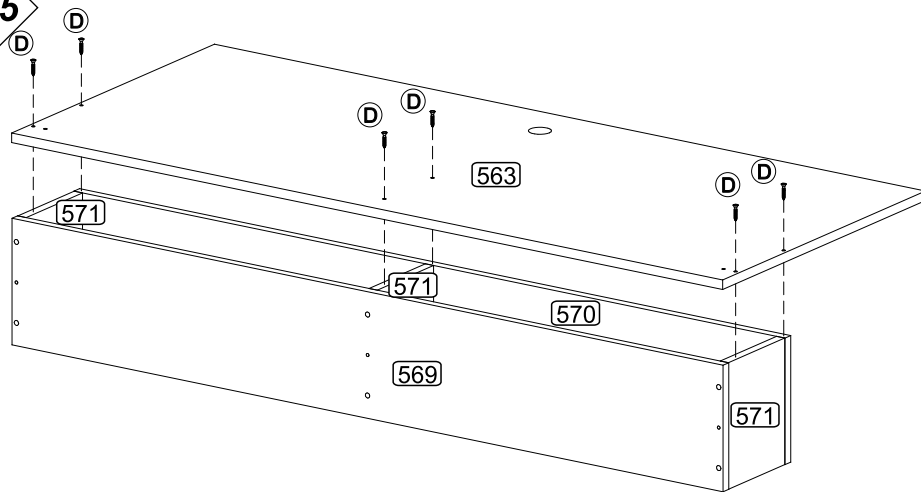

Passo
Paso
Step
06

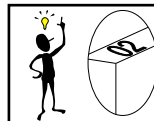
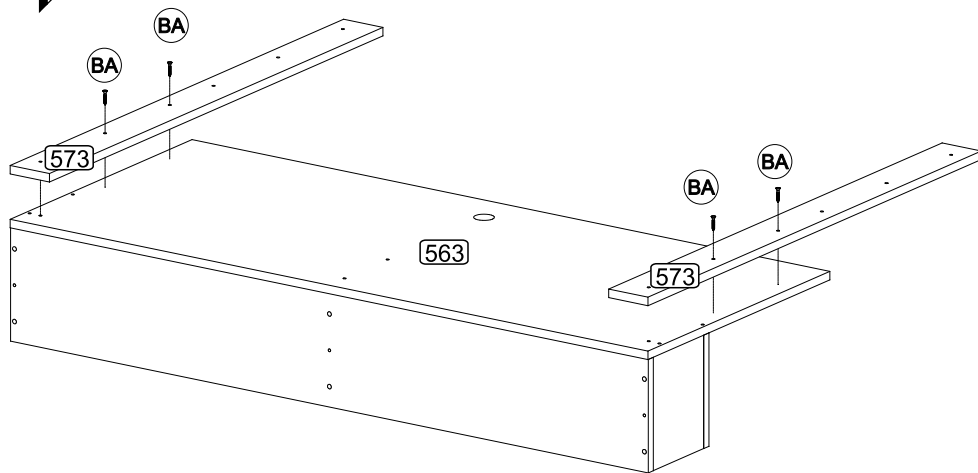

Senhor montador!
Informamos que a numeração das peças encontra-se no topo das mesmas conforme desenho acima.

Señor Armador!
Les informamos que la numeración de las piezas encuentranse arriba de las mismas, de acuerdo al modelo arriba.

Dear Assembler!
We inform you that the number of each piece is located on the top of it, according to the model shown above.

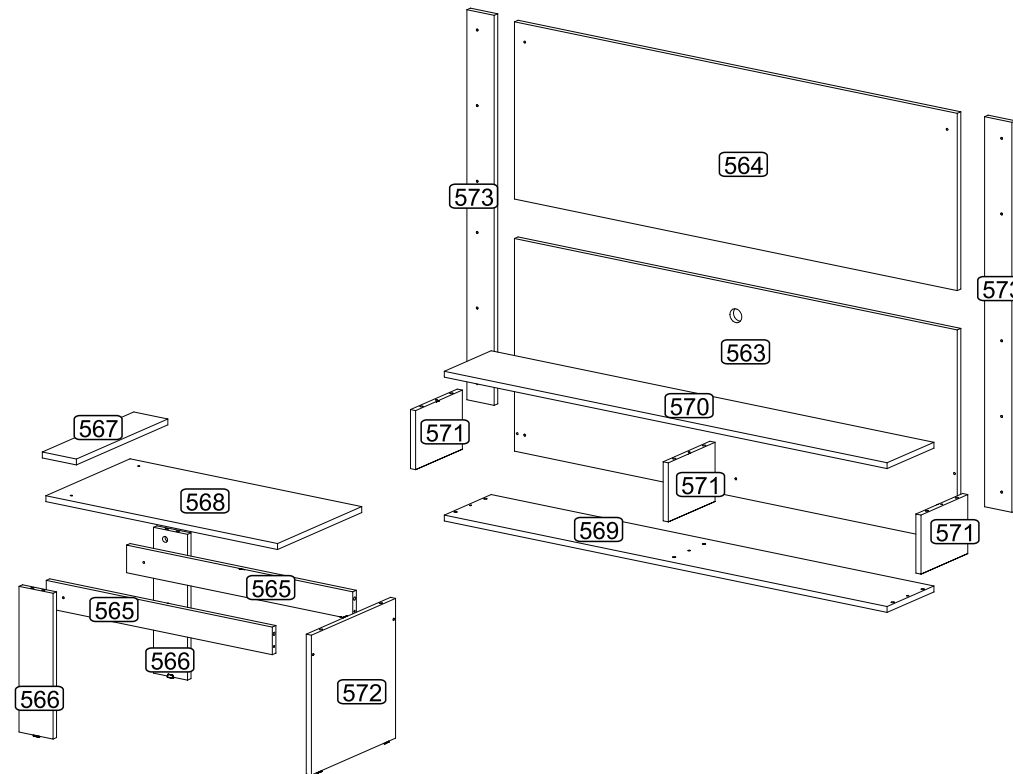

LISTA DE PEÇAS
Nº DENOMINAÇÃO

563	- PAINEL C/ FURO
564	- PAINEL
565	- TRAVESSA MESA
566	- LATERAL ESQUERDA
567	- TAMPO MENOR
568	- TAMPO MESA
569	- BASE
570	- TAMPO
571	- DIVISÃO / LATERAL
572	- LATERAL DIREITA
573	- TRAVESSA



LISTA DE PIEZAS
Nº DENOMINACIÓN

563	- PANEL CON AGUJERO
564	- PANEL
565	- TRAVIESA MESA
566	- LATERAL IZQUIERA
567	- TAPA MENOR
568	- TAPA MESA
569	- BASE
570	- TAPA
571	- DIVISIÓN / LATERAL
572	- LATERAL DERECHA
573	- TRAVIESA



PART LIST
Nº DESCRIPTION

563	- PANEL WITH HOLE
564	- PANEL
565	- CROSS BAR TABLE
566	- LEFT SIDE
567	- SMALLER TOP
568	- TOP TABLE
569	- BASE
570	- TOP
571	- DIVISION / SIDE
572	- RIGHT SIDE
573	- CROSS BAR



ATENÇÃO: É necessário 2 pessoas para montar e fixar o móvel na parede

PRÉ-MONTAGEM / PRÉ-ARMADO / PRÉ-ASSEMBLAGE

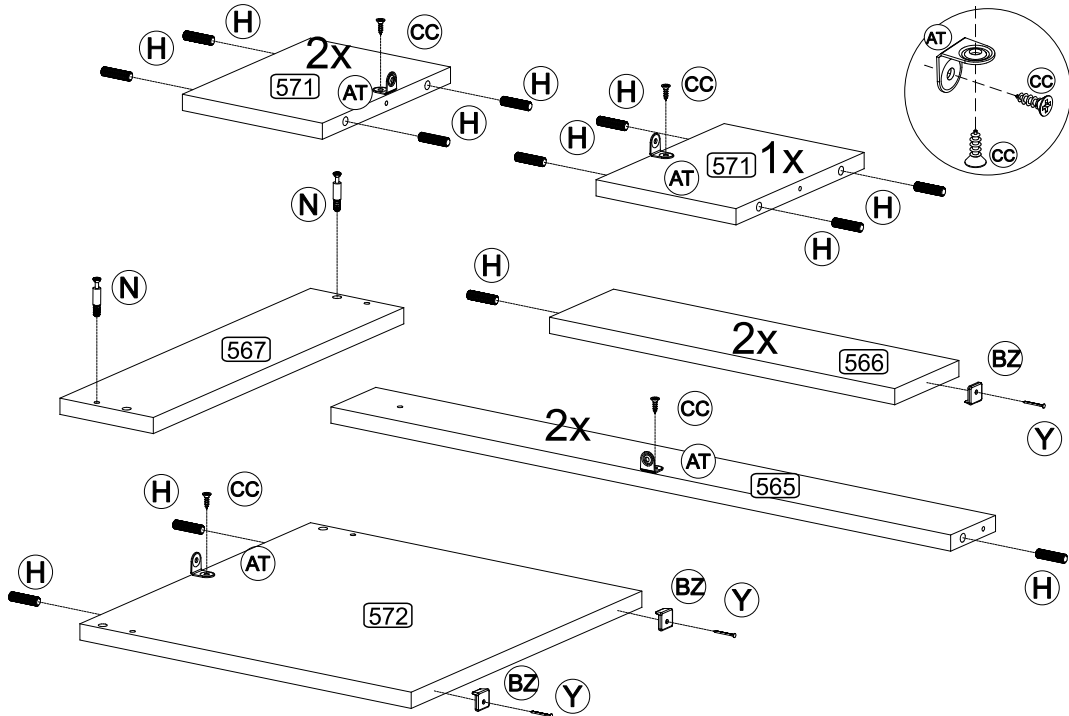

Passo
Paso
Step
01

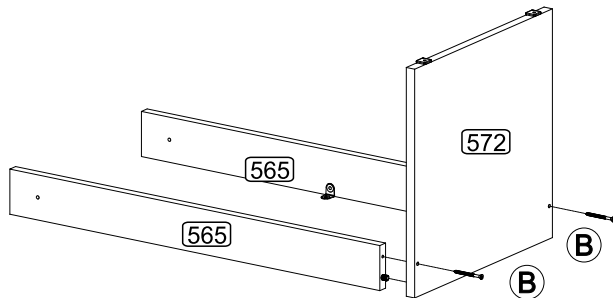
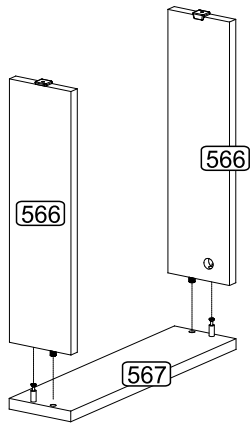
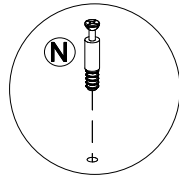
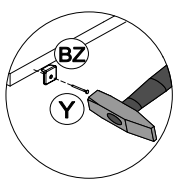
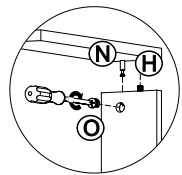

Passo
Paso
Step
02

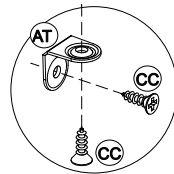

Passo
Paso
Step
03

Passo
Paso
Step
04

